

INSTRUCTION MANUAL

TurbiTechw² Sensors
Covers the LA, LS and HR Versions



YaliTech®

Yalitech Instruments

Santiago de Chile, Río Refugio 9648, Parque de Negocios ENEA, Pudahuel.
www.yalitech.cl · ventas@yalitech.cl · (+56 2) 28988221

** This page is intentionally left blank **

Table of Contents

1 Foreword.....	5
2 Introduction.....	6
2.1 Manual Conventions.....	6
2.2 WaterWatch ² Trademark.....	6
2.3 Scope of Manual.....	6
2.4 External Sensors.....	6
3 Safety Precautions.....	7
3.1 General.....	7
3.2 Electrical installation.....	7
3.3 Operating.....	7
3.4 Service and Maintenance.....	7
3.5 End of Life Disposal.....	8
4 The Sensor and Installation.....	9
4.1 TurbiTechw ² Sensor.....	9
5 Mechanical Installation: TurbiTechw ² LA, LS and HR.....	11
5.1 Installation Considerations.....	11
5.2 Mounting Options.....	12
5.3 Mounting Shaft.....	12
5.4 Handrail and Wall Brackets.....	13
5.5 Flow Cells.....	13
5.6 Customer Supplied Brackets.....	14
6 Electrical Installation.....	15
7 Sensor Configuration.....	17
7.1 Sensor Config.....	17
7.2 Sensor Status.....	17
7.3 Add Sensor.....	17
7.4 S:0x TurbiTechw ² LA, LS or HR: Config Menu.....	18
8 Measurement Configuration.....	20
8.1 Measurement Status.....	20
8.2 Measurement Config.....	20
9 Calibration.....	23
9.1 Calibration frequency.....	23
9.2 TurbiTechw ² LA, LS and HR.....	23
10 Maintenance: TurbiTechw ² LA, LS, HR Sensors.....	28
10.1 Inspection.....	28
10.2 General Cleaning.....	28
10.3 Replacement of Seals.....	28
10.4 Removing the sensor body.....	30
11 Spares.....	31
12 Sensor Faults.....	32
12.1 Unstable reading on controller.....	32
12.2 Error Codes from 7300w ² Monitor.....	32
13 General Application Notes.....	34
13.1 Preparation of Formazin Turbidity Standard.....	34
13.2 Fuller's Earth.....	35
14 Technical Support.....	36
14.1 Returning Equipment for Repair.....	36
15 Technical Specification – TurbiTechw ² LA, LS, HR Sensors.....	37
15.1 Physical.....	37

15.2 Standards.....	37
15.3 Electrical.....	37
15.4 Measurement.....	37
15.5 Mounting Options.....	37

1 Foreword

The TurbiTechw² family of sensors are the latest version of the TurbiTech range. The 'w²' in the product title denotes compatibility with the Waterwatch² range. The sensors are designed for use with the 7300w² Monitor. The term TurbiTech is used for any Partech self-cleaning, Suspended Solids or Turbidity Sensor.

The TurbiTechw² LS Sensor has been designed to monitor the levels of Suspended Solids or Turbidity typically found in Final Effluent from municipal and industrial waste-water treatment plants. It is also capable of monitoring solids in the intake to both effluent and drinking water treatment processes. The normal operating range is between 0 - 50 and 0 - 500 FTU which can be extended to 0-1,000 FTU for specific applications.

The TurbiTechw² LA Sensor has been designed for use in aeration systems typically monitoring Mixed Liquor Suspended Solids also known as Activated Sludge, where solids are typically in the range of 1,500 to 3,500 mg/l. The sensor can also measure Returned Activated Sludge (R.A.S.), Surplus Activated Sludge (S.A.S.) and Suspended Solids or Turbidity in any higher range application.

The TurbiTechw² HR Sensor has been specifically designed for use in waste-water treatment systems where high levels of suspended solids are desirable in the aeration phase. Membrane Batch reactors typically run with MLSS values in the region of 8,000 to 14,000 mg/l. MLSS concentrations promote numerous process benefits, including stable operation, complete nitrification, and reduced biosolids production reducing biological volume requirements (and associated footprint) to only 20–30 percent of conventional biological processes. Further, the membrane tanks provide extremely space efficient solids separation and do not require a clarifier in the system. The TurbiTechw² HR sensor is suitable for monitoring solids in higher ranges than the standard LA version of the sensor due to its shorter path length.

These sensors have a large optical surface and sample volume, which combine to ensure that the sensor is providing measurements that are reliable and representative of the solids present in the process. Deposits of fats and grease on the sensing area do not prevent the sensor from measuring, unlike sensors with small optical surfaces. The TurbiTechw² family of Sensors uses infrared light at 860 nm. The LS uses the Light Scatter principle, whereas the LA and HR uses the Light Attenuation Principle.

These sensors incorporate a self cleaning mechanism that ensures that the optical surfaces are kept clean at all times. The cleaning system is designed to avoid problems with ragging and does not smear the optical system. The cleaning system ensures that manual intervention on a routine basis is not required, and the sensor should simply be checked as part of general site housekeeping.

The cleaning mechanism is sealed by 2 Nitrile 'H' Rings that finish the cleaning process. The Nitrile seals can be exchanged for Viton if the process media dictates. The cleaning process is automatically initiated by the 7300w² Monitor at a user determined frequency. The cleaning process takes only 90 seconds, which means that the sensor is available for dynamic measurement 99.5% of the time on a 5 hourly cleaning cycle.



TurbiTechw² LA, LS and HR

2 Introduction

2.1 Manual Conventions

All dimensions stated in this manual are in millimetres unless otherwise stated.

The manual has been written assuming the user has a knowledge of instrumentation and an understanding of the type of measurement being made. Training in the use of the 7300w² Monitor and sensors can be provided, please contact Partech for further information.

Icons have been used throughout this manual to draw your attention to precautions and useful notes.

They are categorised in the following way:



GENERAL NOTES: Specifications and general notes of interest to the user.



GENERAL CAUTION: Used where caution is required to prevent injury, damage, corruption of data, loss of calibration or invalidation of warranty etc.



INSTALLATION NOTES: General installation notes of interest to the installer.



ELECTRICAL CAUTION: Used where there is a danger of electric shock to the installer or end user, or where caution is required to prevent damage to the instrument.



MAINTENANCE NOTES: Used to highlight recommended maintenance procedures and help with fault finding.



ENVIRONMENTAL NOTES: General notes on environmental issues, waste and disposal.

2.2 WaterWatch² Trademark

WaterWatchw² is the family name for the w² range of monitors and sensors. Sensors and instruments designed for specific use with the 7300w² Monitor will be suffixed with the w² trademark.

2.3 Scope of Manual

This manual describes the installation, configuration, testing and operation of the TurbiTechw² Sensor. Please refer to 7300w² Monitor manual for standard functions of the 7300w² Monitor.

2.4 External Sensors

External sensors refers to any sensors, Expansion Boxes or instruments connected externally to the 7300w² Monitor.

3 Safety Precautions



3.1 General

Read the safety precautions carefully.

Check the delivery of your WaterWatch² sensor for damage. Any damage should be reported to your supplier as soon as possible.

Use care when unpacking the sensor. **NEVER** use sharp instruments to open the packaging, as this can cause damage to the sensor or cable.

Only use accessories specifically manufactured by Partech for use with this sensor.

Read the operating instructions carefully before installing and operating this sensor.

Keep the cable connections dry and free from contamination during installation.

Keep the sensor away from high voltage cables.



3.2 Electrical installation



Only suitably qualified personnel or a competent person may install, operate or repair this equipment. The installer must ensure all electrical installations comply with local wiring regulations and standards (refer to BS7671 for UK installations).

Please check the sensor has been wired correctly. Incorrect wiring may cause damage to the sensor or monitor.

The WaterWatch² family of sensors are designed exclusively for use with the 7300w² Monitor. DO NOT connect to other monitors.

Sensors may need to be correctly addressed to the monitor before use. Please read the *Sensor Configuration* section of this manual for full details.



3.3 Operating

Because these sensors have a wide range of applications, users must acquire the appropriate knowledge to use these sensors in their specific application.

Partech are always available to provide advice and assistance in your application. Please contact Partech for further information.

These sensors may need to be calibrated before use. Please read the *Calibration Configuration* section of this manual for full details of calibration procedures.



3.4 Service and Maintenance

Before maintenance, this equipment must be isolated or disconnected from HAZARDOUS LIVE voltages before access.

Maintenance instructions for the TurbiTechw² sensor should be carried out as specified in this instruction manual. Failure to carry out regular maintenance could invalidate the Warranty.

Services and repairs must be carried out by a Partech engineer. Partech can provide a service contract for your system. Please ask for details.



3.5 End of Life Disposal

Equipment should be recycled according to local regulations.

Any calibration solutions should be disposed of as described in the Manufacture Safety Data Sheet accompanied with the calibration solution.

Partech can provide recycling and disposal of your old Partech equipment, and may also provide the same service for other manufactures equipment when replaced with Partech equipment.

Partech may provide a trade-in for old Partech equipment when upgrading your system. Please contact us for further information.

4 The Sensor and Installation

Whilst every attempt has been made to ensure that these instructions are correct, common sense and good engineering practice should always be used, as every installation can present a new set of challenges and difficulties. If you are in any doubt please contact Partech or your local distributor for further information.

4.1 TurbiTechw² Sensor

All the TurbiTechw² Sensors in the family use an LED infra red light source, which offers long-term stability, low maintenance and high reliability. All TurbiTechw² Sensors use either Light Scatter or Light Absorption to perform their measurement.

4.1.1 TurbiTechw² LS Sensor - Light Scatter

The standard light scatter sensor (LS) is intended to monitor low range suspended solids in the ranges 0-50 up to 0-500 FTU. An alternative sensor with a factory adjustment will allow monitoring upto 1000 FTU, please make sure the correct version has been purchased.

The range of the sensor can be expressed in mg/l depending with the actual range being dependent on the physical nature of the solids present in the sample. There is no universal relationship between FTU and mg/l so it is not possible to simply change the units of measurement. You will need to determine the most appropriate measurement for your application, we are happy to provide advice on this subject if you need assistance.

All range statements are based on the solids present on a typical sewage treatment works and although they are useful as guidance the ranges will be affected by the nature of the solids being monitored. The sensor uses the widely accepted 90° light scatter principle and uses an infra red light source operating at 860nm in accordance with BS EN ISO 7027:2000. The sensor has been designed as a monitor for suspended solids in a variety of applications such as final effluent from treatment works or any outfall into a watercourse or sewer. The sensor can also operate as an inlet suspended solids monitor for water treatment works.

4.1.2 TurbiTechw² LA and HR Sensors : Light Absorption

Light Absorption (LA and HR) sensors are intended to monitor medium to high range suspended solids in the ranges 0-4,000 up to 0-30,000 mg/l (dependent on model, LA or HR). No internal adjustment is available, however measurement outside these ranges is sometimes possible and can be determined by experimentation. All range statements are based on the solids present on a typical sewage treatment works and although they are useful as guidance, the ranges will be affected by the nature of the solids being monitored. These sensors uses an infrared LED light source operating at 860nm.

LA Sensors have been designed to monitor suspended solids in the activated sludge phase of waste water treatment, typically Mixed Liquor Suspended Solids (MLSS) and Returned Activated Sludge (RAS).

HR Sensors have been designed to monitor suspended solids in Sludge Thickening Processes, Membrane Batch Reactors (MBR's), and high concentration Mixed Liquor Suspended Solids (MLSS) and Returned Activated Sludge (RAS).

4.1.3 Self-Cleaning Mechanisms

The TurbiTechw² LA, LS and HR Sensors in the family use the latest revision of the cleaning system that has been employed in Partech sensors for over 25 years. The 2 precision ground Pyrex® glass tubes are withdrawn into the sensor housing each passing through 2 'H' section seals and a polyurethane wiper ring. The wiper ring removes the bulk of the fouling. The first 'H' section seal polishes the measuring surface and the second seal ensures that the main sensor housing remains dry. The seal assembly is the only user serviceable part and will normally need replacement every 2 years or as indicated by the 7300w² Monitor. Further details of seal life and replacement are shown later in the manual.



The servicing routine has been designed to be undertaken without specialist training and should only take 10-15 minutes. Some spare parts are required and should be purchased prior to starting work on the service.

5 Mechanical Installation: TurbiTechw² LA, LS and HR

5.1 Installation Considerations

Reliable accurate measurement from any instrument can only be achieved by correct installation of the measuring device; in the case of the TurbiTechw² Sensors, this is particularly important. If you are in any doubt contact Partech or your local distributor for advice.

Below are some points that should be considered before starting to install the sensor, or in the event an installed sensor gives unreliable measurements:

- Avoid areas of extreme flow or turbulence; air bubbles will disturb the reading.
- Do not place the sensor in an area of no flow, as the suspended solids will settle out and not provide a representative reading.
- Ensure that the sensor is immersed deeply enough into the flow to ensure that any surface flow patterns, such as vortices around the sensor body do not effect the optical parts of the sensor.
- Probes must be kept wet at all times, running the cleaning mechanism with dry probes will cause excessive wear of the wiper and sealing rings, and hence increased maintenance costs.
- The sensor should be mounted in such a way as to allow easy access for calibration and maintenance. It should be possible to remove the sensor from the process without the need to shut the process down.
- The sensor must be monitoring a sample of the process that is representative of the whole process.
- To allow a single technician to calibrate and maintain the system the sensor should be placed within sight of the 7300w² Monitor. Although cable runs of up to 100 metres are possible, operational problems can be caused.
- When possible, angle the sensor so that it is pointing down stream, this will allow any “ragging” to be removed by the flow past the sensor.
- Do not install where there is a likelihood of freezing. Frozen probes will result in cleaning mechanism failure or broken probe tubes.

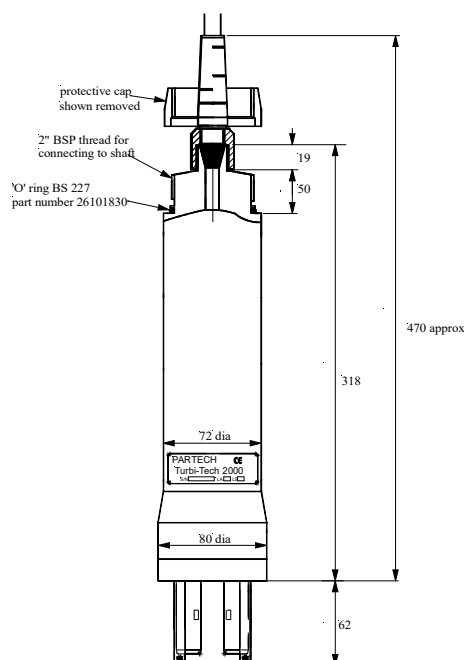

5.2 Mounting Options

Partech offer a range of mounting brackets for the installation of the TurbiTechw² Sensors, which will allow the user to apply the sensor in a wide variety of locations. Drawings of the brackets are shown in the relevant "Optional Accessories" sections of this manual. When assessing mounting options, attention should be paid to the accessibility of the sensor for calibration and maintenance, stability of the sensor in the flow conditions present on site and to ensuring the sensor is fully submerged at all times. It is recommended that the sensor is located in an area where there is sufficient movement to keep the solids in suspension and where any turbulence provides minimum impact on the sensors.

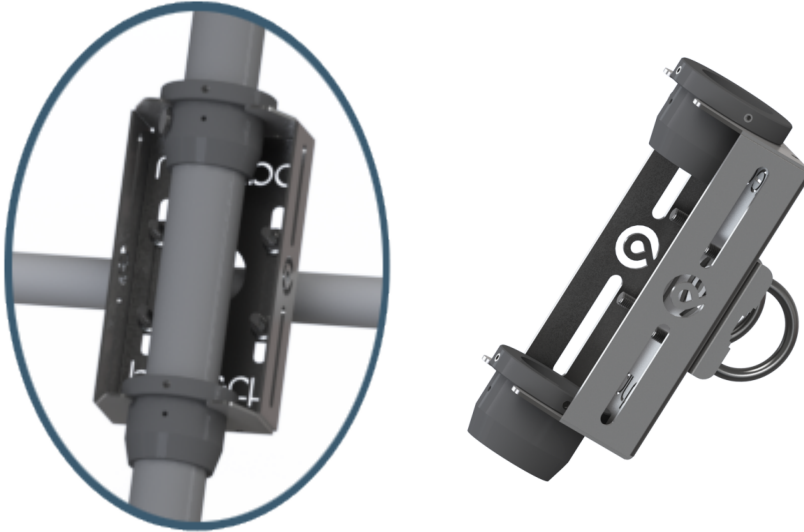

5.3 Mounting Shaft

The TurbiTechw² Sensors are all provided with a 2" BSP male thread that allows the attachment of a number of mounting accessories. Partech supply mounting shafts manufactured from 2" nominal bore grey ABS pipe in 0.5, 1.0, 1.5, 2, 2.5 and 3.0 metre lengths. Whilst other lengths can be provided as special orders, generally standard lengths will satisfy most requirements. It should be noted that sensors with long mounting shafts are difficult to move safely and can present problems with calibration and maintenance, shaft lengths should be kept to a minimum where possible.

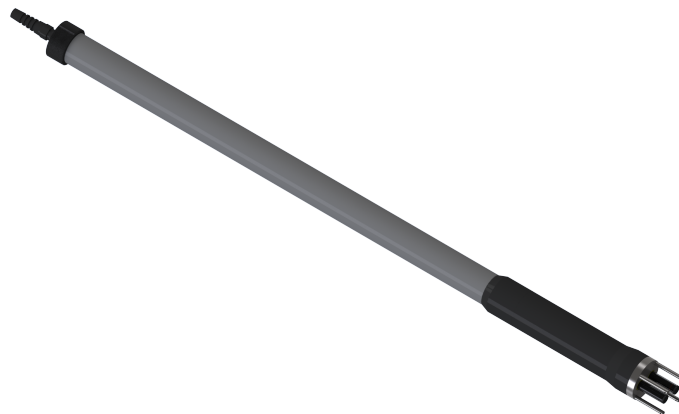

5.4 Handrail and Wall Brackets

The mounting shafts illustrated above need to be attached to the structure of the tank or flow channel where measurement is required. The mounting shaft sits inside the mounting bracket and is located using locking collars. To remove the mounting shaft, remove the locking thumb screw and lift the shaft from the bracket.

Care should be taken to ensure that the sensor can be reached from the walkway to allow removal for calibration and maintenance purposes.

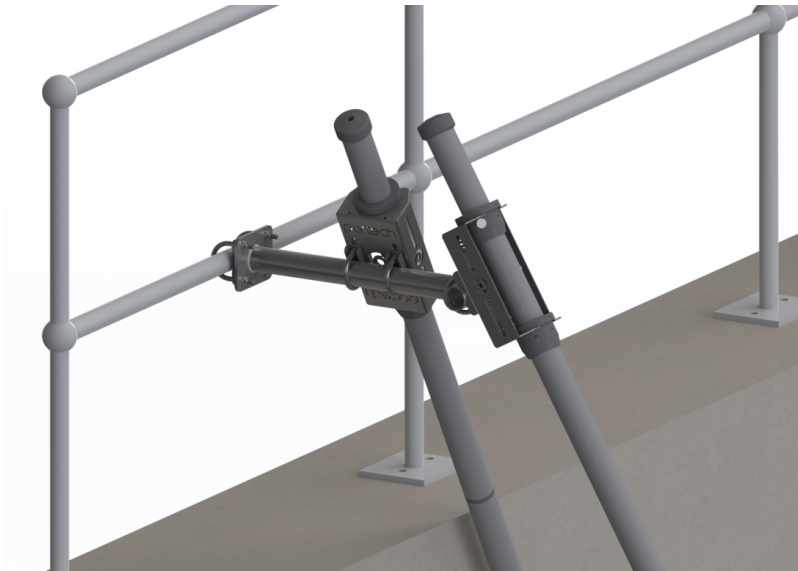

5.5 Flow Cells

Where the process liquid, that needs to be measured, is contained within a closed pipe and no open channel or tank is available, then a sample must be taken and passed through a flow cell to allow the sensor to measure the suspended solids or turbidity. The flow cells provided by Partech are not pressure containing devices and the flow must be fed to waste after passing the sensor.

The flow rate through the flow cell must be sufficient to ensure that the solids do not settle, this is dependant on the solids present but is typically 0.5 to 5 litres per minute.

The flow cell is provided with a $\frac{1}{2}$ " BSP inlet valve with a $\frac{1}{2}$ " BSP male hose adapter and a $\frac{3}{4}$ " BSP outlet valve with a $\frac{3}{4}$ " BSP male hose adapter. The inlet valve will allow the flow to be adjusted to the minimum necessary to ensure that the solids do not settle.

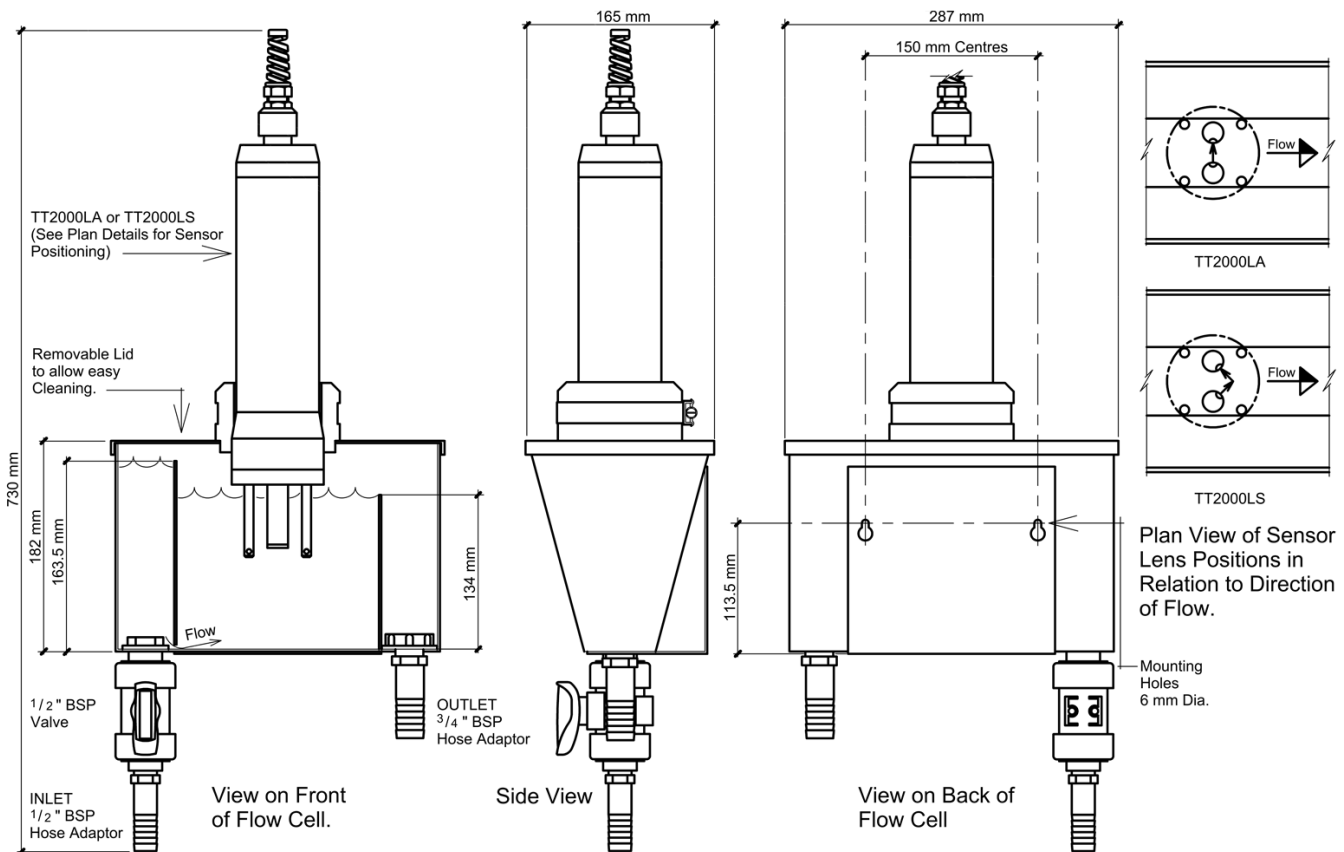

5.6 Customer Supplied Brackets

When creating brackets to mount the TurbiTechw² Sensors, care should be taken to ensure that the following guidelines are observed:

- The bracket must be strong enough to support the sensor with minimum movement when installed into the sample.
- When attachments to the sensor are made, these should either be done using the threaded area at the top of the sensor housing or by clamping around the sensor body.
- Consideration should be given to enable simple removal and replacement of the sensor for inspection, calibration and servicing to be carried out.
- The user bracket does not damage or crush the sensors, effect the flow of sample to be measured or restrict the self-cleaning mechanism.



6 Electrical Installation

6.1.1 Electrical Installation



Unscrew the two cover screws on the lower panel of the 7300w² Monitor to reveal the Terminals. Each terminal strip is labelled as illustrated below. (This equipment must be isolated or disconnected from HAZARDOUS LIVE voltages before access). Refer to the 7300w² Monitor user manual for full description of all the terminals within the monitor.

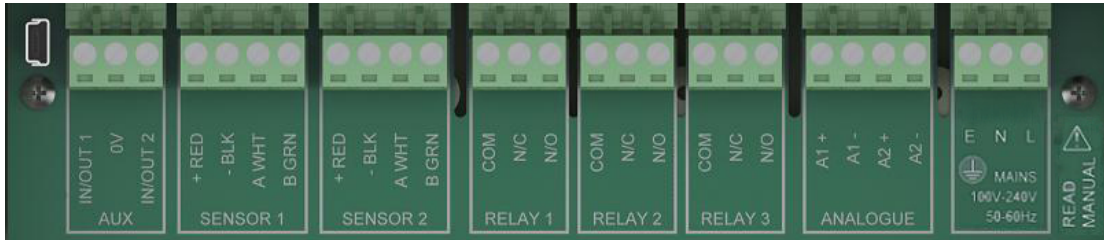

The maximum size wire that can be terminated is 2.5mm² CSA. All the connections are via removable Plug/Socket terminals. To disengage the terminal strip, simply pull down to release.

6.1.2 Sensor Connections

When routing the sensor cables, please ensure the cable is separated from any mains cables. Although the Waterwatch² sensors have a high resistance to interference, separation of mains and data cables is always good practice and should be followed where practical.

All Waterwatch² sensors and Expansion Boxes communicate with the monitor using the ModTechw² Protocol. This protocol is a modified Modbus Protocol and has been specifically developed to take advantage of the advanced features and diagnostics designed into the w² range of sensors.

Note: These sensors can **NOT** be used with other monitors that are not included in the w² family.

All sensors within the w² family of instruments are connected to the 7300w² Monitor using the same 4 wire configuration.

- RED and BLACK wires provide the 12VDC supply to the sensor and the communication ground.
- WHITE and GREEN provide data communication.

A maximum of two sensors can be directly connected to the standard 7300w² Monitor, however additional sensors can be added using the optional Expansion Boxes available separately.

Remove the 4-way connector from the 7300w² Monitor by pulling downwards to disconnect for easy access to the connections. Connect the sensor cores as follows:

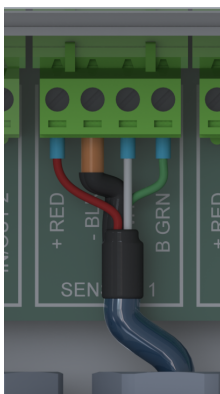

(Terminals from left to right on the 4 way connector)

- | | | |
|----------------|---|----------------------|
| Term 1 (Left) | - | RED (+12V) |
| Term 2 | - | Black (0V) and Drain |
| Term 3 | - | White (Data A) |
| Term 4 (Right) | - | Green (Data B) |

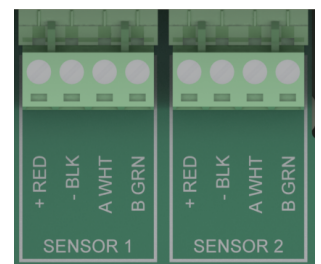

Always connect the screen drain wire with the Black (Term 2). Illustration Left shows drain wire and Black wire connected together, and covered in Black Heat shrink.

Always use Bootlace ferrules when terminating the sensors to ensure a good connection to the terminals.

6.1.3 Extending Sensor Cables

Sensors are usually supplied with 10M cables (longer cables can be provided by request). These cables can be extended to a maximum length of 100M. To ensure optimum performance, we advise the use of Partech ModTechw² cable for extensions. Partech can supply Junction Boxes to allow for easy termination of cable extensions. These should be used on all installations where the cable length from the sensor to the monitor exceeds 20M (Partech Junction Boxes include on-board filtering for long cable lengths). Junction Boxes are also useful for local connection of sensors close to the sample point. This allows for easy replacement of sensors without the need to pull back cables to the monitor. The Junction Box has an on-board terminator switch that can be activated to terminate the network if the sensor is to be removed for long periods.

When joining cables, ensure the connection is fully waterproof. Any moisture ingress can effect the performance of the sensor and monitor. Always ensure the screen is continued when making joints.

ModTechw² Cable specification:

- 2 Twisted Pair: Red/Black (Power) and Green/White (Data) with Screen and Drain wire
- Cores 24AWG (0,22mm²) 7 x 0,20mm
- Outer Insulation: PUR Polyurethane Blue (RAL5003), Diameter - 5mmØ

7 Sensor Configuration

Before attempting to configure the sensor, please read the user manual that came with your monitor. The monitor manual will introduce you to the basic set-up of the monitor, and will familiarise you with the monitor menu structure and buttons.

The monitor leaves the factory with no sensors pre-installed.

Assuming the monitor has been physically connected to a sensor, the next step is to register and configure the sensor before any measurements can be made. A single sensor may provide one or more measurements. We advise only connecting one sensor at a time. Once the first sensor has been registered, connect the second and register again. Repeat for any additional sensors.

All sensors must be registered to the monitor in this way, even if they are different types.

Please note that live measurements are not available until the Measurement Config stage has been completed.

7.1 Sensor Config





Press  to display the MAIN MENU screen, using  highlight SENSOR CONFIG and press .

7.2 Sensor Status



This option allows the user to review the current status of the 8 sensor channels, these will all be set to NOT INSTALLED until a sensor has been added.

Once a sensor has been installed the display will updated to indicate the type of sensor and it's serial number.

7.3 Add Sensor

1. From the MAIN MENU screen, highlight SENSOR CONFIG using  and press .
2. The SENSOR CONFIG screen should be displayed. Press  to highlight ADD SENSOR, and press .
3. The Monitor will now search all possible addresses (0 to 240) to find any attached sensors. During the search, any sensors found will be displayed momentary before continuing with the search. TurbiTechw² sensors have the following default address:
 - 11 = TurbiTechw² LS 0-50 to 0-500
 - 34 = TurbiTechw² LS 0-1,000
 - 12 = TurbiTechw² LA
 - 13 = TurbiTechw² HR
4. Once the search is complete, the Monitor will display a list of sensors found. Each sensor will be automatically allocated a new address from S:01 to S:08.
5. If two or more of the same sensor types are to be installed on a single 7300w² Monitor, the Modbus address must be changed to ensure they do not conflict. See "Modbus Address" later in this manual for details on how to change the address.
6. Repeat the above process to install a second, third or more sensors. A total of 8 sensors are possible (Expansion Box may be required to add additional sensors).

7.4 S:0x TurbiTechw² LA, LS or HR: Config Menu

Once the sensor has been added and registered, the monitor will provide a list of functions specific to the sensor. Use  or  to select the sensor and press . The CONFIG MENU will display a list of sensor functions.

7.4.1 S:0x Manual Clean

This function allows the user to initiate a manual clean cycle. During commissioning it is advisable to perform a manual clean to test the operation of the sensor before installing into the sample (for LA, LS and HR sensors, wet the sensor glass tubes with clean water before initiating the clean. This will help lubricate the seals). This test is also useful for checking the effectiveness of the cleaning action in heavily fouling applications or as part of the sensor servicing routine.

7.4.2 S:0x Info









This function provides a range of diagnostic information that may be requested by Partech for fault finding.

7.4.3 S:0x Remove



This allows the sensor to be removed for re-configuration of the monitor or if a sensor has been added on error. If a sensor has been replaced with a new sensor, the old sensor must be removed, and the new sensor installed.

Sensor removal is carried out in the following way:

1. From the SENSOR CONFIG screen, use  or  to highlight the sensor to be removed i.e. "S:01 TurbiTechw² LS (0-1000)", then press  to select.
2. Use  or  to highlight REMOVE and press .
3. Screen will display "Are you sure?". Press  to remove or  to exit without removing.

Once removed, any Measurement, Alarms or Analogue outputs configured to the measurement will also be removed.







7.4.4 S:0x Modbus Address



All Waterwatch² sensors and Expansion Boxes communicate with the monitor using the ModTechw² Protocol. This protocol is a modified Modbus Protocol, and has been specifically developed to take advantage of the advanced features and diagnostics designed into the w² range of sensors. The term "Modbus Address" has been used as a generic term to describe the address of each sensor and Expansion Box on the Modtechw² network.

Sensors are supplied with default Modbus Addresses, however once the sensor is installed, the Modbus address is automatically changed to the lowest available address (address 1 to 8). This allows a second sensor of the same type to be connected without addressing conflicts.

There may be a need to change the Modbus address to another address (i.e. a spare sensor previously configured to address 1 is installed on a system with a sensor already configured to address 1).

The following describes how to manually change the Modbus address of a sensor:

1. From the SENSOR CONFIG screen, use  or  to highlight the sensor to be re-addressed i.e. "S:01 TurbiTechw² LS (0-1000)", then press  to select.
2. Select MODBUS ADDRESS and press  to select.
3. Press  or  to move the cursor below the digit to be changed.

4. Press  or  to increase or decrease the digit.
5. Press  to accept.

Once the Modbus address has been changed, you are then free to configure the next sensor. Note: The Modbus address is stored in the sensor not the monitor.

7.4.5 S:0x Clean Config Menu

S:0x Clean Interval

This allows this user to set the time between automatic cleans, the time is set in minutes. The factory default setting is 360 Minutes (6 hours), the frequency can be adjusted between 2 and 1440 minutes. Under normal circumstances cleaning should be no more frequent that every 60 minutes. Please remember the more frequently the sensor cleans the quicker the seals will wear out.

Note: a cleaning setting of 360 Minutes will ensure the sensor cleans at the same time every day.

S:0x Clean Mode

The sensor 'clean mode' can be set to Normal, Off or Reverse.

NORMAL: Sets to clean mode to normal operation: Probes extended, and retract to clean.

OFF: This can be used to allow operation of the sensor when there is a fault with the cleaning mechanism or to inhibit the cleaning function for fault finding.

REVERSE: This feature is intended to provide protection for the optical surfaces and cleaning seals in applications with particularly aggressive scaling or fouling problems. The glass tubes will remain retracted until instructed to extend to make a measurement, they will remain extended long enough to obtain a stable reading , the actual duration will depend on the averaging g setting applied. This feature will cause reduced seal life and care needs to be taken to ensure that the seals are replaced before they fail.

S:0x Service Life

The factory setting for the sensors is 3500 cleans between services, this equates to around 2 years of normal operation (6 hourly clean). This service life will need to be adjusted in some applications due to the variable nature of the solids being monitored. Abrasive solids such as sand will cause the seal to wear out more quickly.

S:0x Clean Service

This allows the user to reset the clean counter when a service is carried out.

S:0x Clean Info

This option reports the number of cleans carried out by the sensor since the last reset, the time of the next clean and estimated service life

S:0x Clean Error Reset

Selection of this option will reset the clean fault flag. The flag will be set on a clean fault, and will remain set until reset.

S:0x Retract

This option will retract the probes manually. This is useful prior to installation, placing the sensor into storage or sending for service to protect the probes.

S:0x Extend

This will extend the probes manually after a Retract was issued.

8 Measurement Configuration

The monitor leaves the factory without any measurements configured. Measurements can only be added after installing the relevant sensor(s).

Once the sensor(s) have been registered with the monitor and installed, the measurements can now be configured.

The LA and LS versions of the TurbiTechw² sensor have a single measurement available that can be configured for all intended applications. The HR version offers the option of using g/l or mg/l, the normal units for this sensor are g/l which provides a clear display of the measured value, some customer may prefer mg/l which is available as an optional measurement accessible from the Add Measurement function.









8.1 Measurement Status

This option allows the user to review the current status of the 16 measurement channels. Configured measurements will show the type of measurement and description and serial number of the sensor providing the measurement. If only one measurement is configured, the remaining fifteen measurement allocations will display "DISABLED".

8.2 Measurement Config

From the MAIN MENU screen, select MEASUREMENT CONFIG using  to highlight and press .

8.2.1 Add Measurement

1. From the MAIN MENU screen, select MEASUREMENT CONFIG by pressing  or , and press .
2. The MEASUREMENT MENU should be displayed. Press  to highlight ADD MEASUREMENT, and press .
3. All available measurements will be displayed in a list. Press  or  to highlight the first measurement.
4. Press  to select the measurement. Repeat the process if more measurements are required.
5. Each measurement will be allocated a measurement number from M01 – M16. A total of 16 measurements may be displayed.

N.B. The measurement number has no relevance to the sensor number.

6. Press  to return back to the display screen. The first configured measurement should now be displayed.

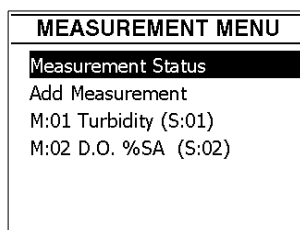

The Measurement Menu will list all configured measurements in order M:01 to M:16 the list will also indicate the sensor number that is delivering the signal for the measurement. (Note: the above screen shot is an example of measurements loaded from a Turbidity sensor).

8.2.2 M:0x Info

This option provides additional information on the measurement this information will only be required if a problem exists with the instrument performance.

8.2.3 M:0x Title

This allows the title of the measurement to be changed from its default, the measurement title is used in measurement mode to identify the measured value. A selection of standard terms are available along with a 'User Defined' option that can be adjusted to suit your requirements. For example this could be changed to 'MLSS – Lane 1'. The maximum number of characters is 20.

8.2.4 M:0x Units

This allows the units of the measurement to be changed from its default, the measurement units are used in measurement mode. A selection of standard terms are available along with a 'User Defined' option that can be adjusted to suit your requirements. The maximum number of characters is 4.

8.2.5 M:0x Set Zero

Used for calibration. Sets the calibration Zero. The terms relate to the calibration of the system and are covered in the section below.

8.2.6 M:0x Set Span

Used for calibration. Sets the calibration Span or high limit. The terms relate to the calibration of the system and are covered in the section below.

8.2.7 M:0x Take Sample

Used for calibration. Allows a sample value to be stored and results entered later. The terms relate to the calibration of the system and are covered in the section below.

8.2.8 M:0x Sample Result

Used for calibration. Allows a sample value to be entered later. The terms relate to the calibration of the system and are covered in the section below.

8.2.9 M:0x Averaging



This allows the user to impose averaging on the measured value, this is used to reduce the speed of reaction to the process changes.



The following values are available for the user to select:

Damping Rate	Response Time (Seconds)	Typical Use
Instant	0.2s	Instrument demonstration and test
Very Fast	1s	
Fast	10s	Final effluent monitoring
Medium	30s	
Slow	1m	Activated sludge (MLSS) applications
Very Slow	2m	Applications with high levels of air bubbles or turbulence

8.2.10 M:0x Remove

If a measurement is no longer required, the measurement configuration can be removed from the 7300w² monitor in the following way.

- From the MEASUREMENT CONFIG screen, use  or  to highlight the measurement to be removed i.e. "M:01 Turbidity (S:01)", then press  to select.

2. Select REMOVE and press  to select.
3. Screen will display "Are you sure?". Press  to remove or  to exit without removing.











Once removed, any Alarms or Analogue outputs configured to the measurement will also be removed.

8.2.11 M:0x Display Position

Display Position allows two measurement to swap places, to allow the user to re-arrange the display as required. The display position refers to the M:0# number allocated to the measurement. The screen will always display the measurements in order from M:01 to M:16.

To swap measurements, use the DISPLAY POSITION menu.

The example below swaps measurement M:01 with M:03:

1. From the MEASUREMENT CONFIG screen, use  or  to highlight the measurement to be moved i.e. "M:01 Turbidity (S:01)", then press  to select.
2. Select DISPLAY POSITION using  or  and press  to select.
3. The current display position will be shown, e.g. 1 for M:01 Turbidity.
4. Press  or  to move the cursor below the digit to be changed.
5. Press  or  to increase or decrease the digit to the desired new position (e.g. 3)
6. Press  to accept. Measurement M:01 will now become Measurement M:03, and the measurement registered as M:03 will now become measurement M:01.
7. Note: any alarms or analogue outputs registered to a specific measurement will also be updated to the new display position (it is not necessary to re-configure alarms or analogues).

9 Calibration

When a new system is installed, a period of 4 hours should be allowed for the TurbiTechw² Sensor to stabilise before calibration commences. This is to enable the system to adjust to the “new” ambient conditions. This should not be considered as system warm up time from power up, but to acclimatise to the environment if the sensor has come from a warm store to a cold sample point.

The standard calibration procedure involves a two point calibration – zero and span, the process for calibration is described below. The sensors have linear responses to most the solids found in most applications, if a particular application has a non-linear response it is possible to adapt the response of the sensor to improve accuracy, this must be carried out in consultation with Partech.

If a calibration solution or pre-pared sample is not available then the Take Sample option below can be used, it is often acceptable for an estimated span value to be entered to get the measurement started, this must however be replaced by a valid calibration using one of the methods described here as soon as possible to ensure accurate measurement.

It should be noted that changes to the nature of the solids present in the process being monitored can cause changes in the sensor response requiring re-calibration.

Any containers used to store calibration samples should be cleaned prior to use. This is particularly important when performing the zero point calibration on a low range sensor.

The most accurate method of calibration is using a primary standard, i.e. calibration in the actual solution against a lab result. This can be carried out by using either a sample of known value (established using a laboratory test) or the Take Sample routine described below. Where this is not possible or where the trend of the reading is necessary rather than an absolute value it is acceptable to use a secondary standard. It is normally preferable to perform the calibration operation with the damping on the controller set to zero.

If further guidance is required [please contact our Technical Support Engineers to discuss your requirements.

9.1 Calibration frequency

There is no absolute guide to the frequency of calibration, the user must make a judgement based on how critical the measurement is to the process, variability in the sample and standard practice within their organisation.

We recommend that calibration is carried out at commissioning stage and is then repeated within 4 weeks to ensure the instrument and process conditions are stable. After this a default calibration frequency is every 6 months.

9.2 TurbiTechw² LA, LS and HR

This section describes calibration of the Turbidity or Suspended Solids measurement using a pre-pared sample or calibration solution.

9.2.1 Equipment required for Calibrations

This section describes the materials and equipment you will need, and the basic steps required to ensure a successful calibration of the TurbiTechw² LA/LS or HR Sensor.

The following is required:

- 10 Litres filtered distilled water
- 2 Litres secondary standard (Formazin/Fullers Earth)
- Large container approx 10 Litre (bucket is suitable), ideally black, for Zero calibration point.
- 200 mm diameter 2-litre container, ideally black
- Protective gloves.

- Stainless steel spoon.

The use of protective gloves is recommended when performing calibration procedures.

Prior to taking any measurements, thoroughly wash the containers, mixing spoon, sensor and 1 meter of the sensor cable. Then rinse everything twice with filtered water (any contamination will effect the zero calibration).

Ensure that calibration solutions are stirred before use.

If possible, perform the calibration procedure under fluorescent light to avoid interference from incandescent light and solar radiation.











Always immerse the sensor in the containers so that the IR beam looks across the main body of the sample to prevent the beam from reflecting off the walls on the container.

Note: When calibrating in the field, where possible, perform checks in the shade to minimise the effects of stray-light.

9.2.2 Zero Calibration

To zero the system, immerse the sensor in clean water (Use a black or dark container for the calibration solutions to restrict external light effecting the calibration). When the TurbiTechw² Sensor is immersed, care should be taken to ensure the sensor is not looking at the side of the container, as this will give inaccurate calibrations. If the optics of the TurbiTechw² Sensor are observed it will be noticed that the lenses are facing in a specific direction, ensure that they are pointing into the main volume of the sample.

From the 7300w² Monitor, navigate to the Calibration menu as follows:

- Press  to show the "MAIN MENU".
- Select "MEASUREMENT CONFIG" using  to highlight and press .
- Select the measurement to be calibrated using  to highlight and press .
- Select "SET ZERO" using  to highlight and press .
- The SET ZERO screen will be displayed, press  to accept. The ZERO Calibration screen will be displayed.
- Wait for the value to stabilise, then press  to accept.
- Press  several times to return back to the DISPLAY screen.
- Zero calibration is now complete.

9.2.3 Span Calibration using a Prepared Standard or Sample

The span point needs to be selected to be representative of the process being monitored with due regard to the normal operating conditions. For a final Effluent monitoring application where the discharge consent is 30 mg/l we would suggest the calibration is carried out at around 30 mg/l. For an Activated Sludge Application with a Suspended Solids control band of 1,500 to 3,00 mg/l we would suggest calibration at 3,000 mg/l.

Primary Standard

It is sometimes possible to take a sample of the process and have this analysed to determine the Suspended Solids content. To do this we recommend at least 5 litres is taken from the process with a small amount being taken to the laboratory and the bulk being retained for use with the sensor. The sample must be representative of normal process conditions, and the sample should be keep in conditions that do not allow deterioration whilst the analysis is being carried out.

The Suspended Solids analysis should be carried out using sound laboratory practice, a number of techniques exist, we recommend Method 2540D described in the Standard Methods for Examination of Water and Wastewater published by American Public Health Association (ISBN 0-87553-047-8). We can provide advice on this subject if required.

Once the sample has been analysed the process below can be followed.

Formazin

For Turbidity monitoring it is often preferable to use a secondary calibration solution, this allows comparison to other part of a process or across different sites. Care needs to be taken if the measurement is being taken for regulatory purposes and due regard must be paid to the requirements to regulator.

Formazin is a widely accepted secondary standard and can be purchased from laboratory suppliers pre-prepared at defined values. Please note that 2 litres of the solution is required to carry out the calibration.

Calibrating with Formazin allows the use of FTU, FNU and FAU as the units of measurement. The units on the 7300w² Monitor should be changed to reflect this. It should be noted that there is no universal relationship between FTU's and mg/l, although it may be possible to derive a relationship by experimentation for a particular application.

If preferred a stock solution of Formazin can be prepared on site, this is described later in this manual. Please note that the stock solution needs to be prepared at least 24 hours before use. Once a Formazin stock solution has been prepared, it can be diluted to the required value.

Once the Formazin solution is available use the process below.

Fuller's Earth

The use of Fuller's Earth is an alternative method of calibrating the TurbiTechw² Sensor. It should be noted that this would produce only an indication of the value being measured. Fuller's Earth has fallen out of common use, however, is included to give an alternative method of calibration if gravimetric analysis is not possible.

Prepare the Fuller's Earth sample as detailed later in this manual, to the value required.

Place the sensor in the sample, ensure that the Fuller's Earth has not settled out, and perform the calibration.







Once the Fuller's Earth solution is available use the process below.



Calibration Process

To set the span calibration point for the system, immerse the sensor in the sample/solution described above (use a black or dark container for the calibration solutions to restrict external light affecting the calibration).

When the TurbiTechw² Sensor is immersed, care should be taken to ensure the sensor is not looking at the side of the container, as this will give inaccurate calibrations. If the optics of the TurbiTechw² Sensor are observed it will be noticed that the lenses are facing in a specific direction, ensure that they are pointing into the main volume of the sample.

From the 7300w² Monitor, navigate to the Calibration menu as follows:

- Press  to show the "MAIN MENU".
- Select "MEASUREMENT CONFIG" using  to highlight and press .
- Select measurement to be calibrated using  to highlight and press .
- Select "SET SPAN" using  to highlight and press .

- The SET SPAN screen will be displayed, press  to accept. The SPAN Calibration screen will be displayed.
- Wait for the value to stabilise, then press  to accept.
- Press  several times to return back to the DISPLAY screen.

Span calibration is now complete.

9.2.4 Span Calibration using the Take Sample Routine











The Take Sample and Sample Result menus are provided to allow calibration to be carried out retrospectively based upon stored information. An example of this is where the value of the calibration solution is not known at the time of calibration and an estimated value was used to set the instrument span. The take sample menu is used to store the sensor signal of the calibration solution for later use.

The Set Zero process described above should be carried out before using the Take Sample routine.

Take Sample



Immerse the sensor into a black or dark container, containing a sample representative of the normal operating conditions expected from the sample point. When the TurbiTechw² Sensor is immersed, care should be taken to ensure the sensor is not looking at the side of the container, as this will give inaccurate calibrations. If the optics of the TurbiTechw² Sensor are observed it will be noticed that the lenses are facing in a specific direction, ensure that they are pointing into the main volume of the sample. For some applications it is preferable to place the sensor directly in its normal location, in this the sample must be taken from immediately next to the sensor. Care is also needed to ensure that air bubbles are not causing a calibration error.













From the 7300w² Monitor, navigate to the TAKE SAMPLE menu as follows:

- Press the  to show the "MAIN MENU".
- Select "MEASUREMENT CONFIG" using  to highlight and press .
- Select measurement to be calibrated using  to highlight and press .
- Select "TAKE SAMPLE" using  to highlight and press .
- The TAKE SAMPLE screen will be displayed, press  to accept.
- Wait for the value to stabilise, then press  to accept the current reading. The sample value will now be stored in the sensor.
- Press  several times to return back to the DISPLAY screen.
- Zero calibration is now complete. The sensor will continue to measure using the original calibration values, however the sample value, time and date will be stored until required.
- The sample must now be analysed by a laboratory to establish the Turbidity or Suspended solids present. Once this information is attained, the value of the sample can be entered into the sensor using the SAMPLE RESULT menu.

Sample Result

Once the sample result has been established, the result can be entered into the sensor in the following way:

- Press  to show the "MAIN MENU".
- Select "MEASUREMENT CONFIG" using  to highlight and press .

- Select measurement to be calibrated using  to highlight and press  .
- Select “SAMPLE RESULT” using  to highlight and press  .
- The SAMPLE RESULT screen will be displayed, press  to accept.
- The time and date of the last Take Sample will be displayed for the users reference. Press  to accept.
- Press  or  to move the cursor below the digit to be changed.
- Press  or  to increase or decrease the digit. Enter the known value of the sample.
- Press  to accept the new calibration value.
- The sensor is now calibrated.
- Press  several times to return back to the DISPLAY screen.



10 Maintenance: TurbiTechw² LA, LS, HR Sensors

To maximise the operational life of the sensor, regular inspection and servicing is required. The frequency of this is dependent on the specific operation of each site, however an initial weekly inspection to observe the characteristics of the application is recommended, long term operational practice can be decided from these inspections.

Although the sensor will automatically clean the optical surfaces of the sensor the main sensor body and the mounting brackets will be subject to fouling. It is advisable that this fouling is not allowed to build up to such an extent that it affects the sensors ability to make the required measurement.

10.1 Inspection

Regular inspection of the sensor should include the following:

- Check security of brackets.
- Check for damage to cable.
- Removal of the sensor from the channel.
- Cleaning the sensor using a suitable detergent and remove all ragging.
- Inspection of the glass tubes for staining, scouring, cracks or chips.
- Check for moisture/signs of leakage inside the glass tubes.

10.2 General Cleaning

The optical part of the sensor uses two precision ground Pyrex glass tubes, care must be taken at all times not to damage or break the tubes. This is particularly important if the sensor is removed from the process for maintenance or inspection. Damage to the tubes will cause the sensor to leak. If any problem is found please contact Partech's Customer Support Manager before attempting to repair the sensor.

The frequency of cleaning can be set on the 7300w² Monitor to meet the requirements of the application. It is possible to set the interval between cleaning in the range 30 minutes to 24 hours. The interval should be set to suit the level of fouling experienced in a particular installation. The factory default clean interval is set to 5 hours, however this may be adjusted. The best method of optimising the clean cycle interval is through observation of the probes prior to a clean taking place. An assessment of the level of fouling can then be made and the clean interval adjusted accordingly.

At a 5 hourly cleaning cycle the cleaning rings will last for approximately 730 days or 2 years. The actual wear rate of the cleaning rings is dependent on the solids being measured; an abrasive process will cause the seals to wear more rapidly. It should be noted that the wiper and sealing rings are rated for 3500 clean operations; therefore using a short clean interval reduces the service interval of the sensor. An error message is displayed on the 7300w² Monitor when the sensor has performed 3500 clean cycles.



10.3 Replacement of Seals

This guide details how to replace the TurbiTechw² Sensor seals using a TurbiTechw² Sensor Seal Service Pack. Please refer to the Spare part section of the manual for part numbers and ordering descriptions.

The pack contains the following parts:

- 1 off Seal Assembly. The Seal Assembly is supplied with four 'H' rings and an 'O' ring fitted.
- 2 off Wiper Rings.

10.3.1 Preparation

Prior to replacing the seals, the sensor should be cleaned using water and a mild liquid detergent. After cleaning the sensor should be wiped dry.

10.3.2 Replacement of Seals

It is preferable to carry out this operation with the probes fully extended. However, replacement of the seals can be done even if the probes are partially or full retracted.

(Note: The numbers in brackets identify the parts in the “Exploded view” illustration in the “Technical Specification” section of this manual).

1. Switch off the power to the 7300w² Monitor or disconnect the 4 way terminal strip from the monitor.
2. Unscrew the four guard rods (17). A small Allen key or similar is suitable for using as a lever in the small hole located near the end of the guard rod.

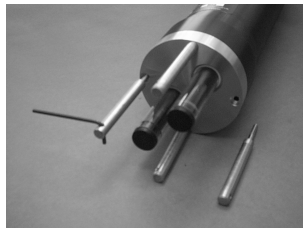

3. Remove the stainless steel wiper ring housing (16) and carefully prise the wiper rings (15) off the glass tubes (12, 13). Discard the worn wiper rings.



4. In the centre of the now exposed seal assembly (14) a small threaded hole should be visible. Fit the stainless steel wiper ring housing onto the probes in a reverse direction to its correct installation. Screw one of the guard rods through the wiper ring housing centre hole into the threaded hole in the centre of the seal assembly.



5. The reversed wiper ring housing can now be used as a lever to extract the seal assembly down and off the probes. This is best done by locating fingers underneath the wiper ring housing and thumbs on the ends of the probes.



6. Unscrew the guard rod from the old seal assembly and remove the wiper ring housing. Retain the seal assembly for return to Partech.
7. At this stage, it may be necessary to clean the glass tubes. A damp soft cloth and some mild liquid detergent are suitable for this, however great care should be taken to ensure no water enters the sensor body.

8. Around the rim of the body are four threaded holes and one location hole. Align the red ringed probe with the location hole then fit the replacement seal assembly onto the probes such that the small threaded hole is facing outwards and the second location hole on the seal assembly is to the right of the red ringed probe. Gently slide the seal assembly over the probes and press fully home into the sensor body. Both the body and seal location holes should align with the two location pins in the wiper ring housing.
9. Fit the replacement wiper rings over the probes and slide up to the seal assembly.
10. Locate the wiper ring housing onto the probes such that the small location dowels are aligned with their mating holes in the sensor body and seal assembly. Slide the wiper ring housing onto the sensor body.
11. Replace the guard rods ensuring that the wiper ring housing is square to the sensor body. It should be possible to tighten the guard rods such that there is no gap between the wiper ring housing and sensor body by hand. A small Allen key or similar can be used to tighten the guard rods - care should be taken to prevent over tightening.

10.4 Removing the sensor body

The sensor body can be removed to enable inspection of the cleaning mechanism, circuit boards and the adjustment of the gain control on the light scatter version of the TurbiTechw² LS Sensors. If removal of the body is required, steps should be taken to prevent any moisture entering the sensor body and any damage being done to the cleaning mechanism and circuit boards.

To remove the sensor body in order to gain access to the sensor circuit boards and cleaning mechanism, follow steps 1 to 7 of the seal replacement procedure. Then continue as follows:

(Note: The numbers in brackets identify the parts in the "Exploded view" illustration in the "Technical Specification" section of this manual).

1. With the seal assembly removed from the sensor housing, gently pull the probes such that the sensor inner assembly is removed (6 - 13).
2. Withdraw the sensor inner assembly completely from the body. The connecting cable is long enough to permit complete removal.
3. If required, the connecting cable can be removed from the sensor circuit board by unplugging and sliding through the wire support disc.
4. To refit the sensor inner assembly the procedure is the reverse of the above three steps and continues with steps 9 to 11 of the seal replacement procedure. Care should be taken to ensure that the connecting cable is securely fastened and it is not snagged when the sensor is replaced into the body.

11 Spares

11.1.1 Service Parts

229239 (previously 156260).....	Seal Service Pack - TurbiTechw ² LA/LS, Nitrile H Rings
229240 (previously 156261).....	Seal Service Pack - TurbiTechw ² LA/LS, Viton H Rings
229241 (previously 220607).....	Seal Service Pack - TurbiTechw ² HR, Nitrile H Rings
229242 (previously 220608).....	Seal Service Pack - TurbiTechw ² HR, Viton H Rings

When ordering seal packs, always provide the model number and serial number of the sensor to ensure the correct seal pack is supplied.

11.1.2 Calibration

101940.....	Fullers Earth Pack
102130.....	Formazin Pack



12 Sensor Faults

12.1 Unstable reading on controller

The following can cause an unstable display value:

- Material (rag, weed, etc.) caught on the sensor probes, guard rods and affecting the measuring system - remove sensor, manually clean and re-install.
- Turbulence (caused by high flow, aeration etc.) in the solution being measured - increase the level of damping on the 7300w² Monitor.
- Bad connection in the sensor cable : check all connections are secured.

12.2 Error Codes from 7300w² Monitor

The 7300w² Monitor will provide a number of error codes, the majority are generated by and stored in the sensor. Some messages are warnings, such as Clean In Progress which do not require any action.

12.2.1 Input High Limit/Low Limit

This indicates that the measured value is outside the normal operating limits of the sensor. This could be caused by sensor fouling but can also indicate a genuine failure of the optical components.

The following action is recommended:

1. Clean the optical surface of the sensor by hand
2. Place the sensor in air (LS, LA, HR)
3. Place the sensor in a sample (alternatively place an object in front of the optics).

At each stage observe the behaviour of the displayed value. If the error message clears then it is possible that the problem was caused by fouling or by the presence of an object in the sensors optical path.

If the problem returns when the sensor is returned to it's normal location, it is worth checking the Suspended Solids/Turbidity present in the sample against the specified range of the sensor. It is possible that the nature of the application has changed.

If the problem persists please contact Partech or your local representative for further guidance.

12.2.2 Over range/Under range

This indicates that the sensor is receiving a valid measured value that is outside the limits of the measurement configuration. i.e 10,000 mg/l when the display range has been set to 5,000 mg/l.

Firstly check that the plant is working normally and that the sensor has not become damaged or fouled.

If the sensor is working correctly and the site is operating normally then it may be necessary to change the configuration of the measurement. This is explain earlier in this manual.

12.2.3 Clean in Progress

This indicates that the sensor is carrying out a routine clean cycle, this should take 90-120 seconds (LS, LA or HR). If the message persists beyond this time, check the position and behaviour of the sensor, the glass tubes are not moving then it is possible that the clean system has a problem that has not yet created a clean fault alarm.

12.2.4 Clean Fault (LS, LA or HR).

This indicates that a faults has occurred with the clean system, potential causes include:

- A clean cycle not being completed within a set time.
- An internal fault has occurred within the sensor.
- Sample frozen. In extreme weather conditions, removing the sensors from the sample for long periods can cause the damp probes to freeze causing a Clean Fault. Always wipe the probes dry with a dry cloth when removing the sensor from the sample in very cold conditions.

To investigate the cause of the clean fault, turn off the power to the 7300w² Monitor, remove the sensor and manually clean the sensor as described previously. Inspect the glass tubes for damage and excessive build up of residue (if these have occurred the sensor needs to be serviced).

If once the sensor has been cleaned and there is no damage, switch the 7300w² Monitor ON. The sensor probes should move to the fully extended position (unless they were already fully extended). Once the probes are fully extended use the manual clean option on the 7300w² Monitor to initiate a clean cycle. Observe the probes throughout the clean cycle, making sure that the clean status indicated on the 7300w² Monitor follows the action of the sensor.

13 General Application Notes

13.1 Preparation of Formazin Turbidity Standard

Preparation of Formazin Turbidity Standard for Calibration.

13.1.1 Health & Safety Precautions

The chemicals used when following this procedure are harmful, therefore the correct safety precautions must be carried out. During handling, avoid inhalation and contact with the eyes or skin. Wash hands thoroughly after use. Refer to the Manufacture Safety Data Sheets for further details of the chemicals used.

13.1.2 Method of Preparation

The preparation of a Formazin Turbidity Standard should be carried out with great care. Absolute cleanliness should be observed at all times to avoid any contamination of the solution.

All water used should be freshly distilled or de-mineralised. During preparation and use, keep the solution covered to prevent contamination.

- Dissolve the Hydrazinium Sulphate 10g (32112680) into 1 litre of water. Stir the solution thoroughly.
- Dissolve the Hexamine 100g (32112630) into 1 litre of water. Stir the solution thoroughly.
- Pour the above solutions into a 2.5 litre Winchester or similar type amber glass bottle and mix thoroughly. Allow the mixture to stand undisturbed for 24 hours at 25°C. The resultant solution will have a turbidity of 4000 FTU.
- Prior to use the standard should be mixed thoroughly, i.e. before pouring out the standard, shake the bottle well.

13.1.3 Preparation of Dilution's.

The 4000 FTU standard can be used to prepare solutions of lower values by diluting with water. The formula below can be used to calculate the ratio of water to 4000 FTU standard to produce a solution of the required value.

$$W = \frac{4000}{A} - 1$$

W = parts water to 1 part 4000 FTU standard

A = Required FTU value

The Formazin Dilution Chart (table QAP 6.14.4) provides the mixture requirements to make various solutions using the 4000 FTU standard.

13.1.4 Calibration

When Formazin solutions are used for calibration/testing of sensors, sufficient solution is required such that the sensor is completely immersed. When using light scatter sensors it is important that the sensor is positioned away from the sides and bottom of the container to prevent the light being reflected.

13.1.5 Storage Life

The turbidity standard should be stored in a Winchester bottle and kept in a cool dark place. The bottle should be labelled to identify its content and also the date of preparation should be recorded. The 4000 FTU standard has a shelf life of one year after which it should be discarded and a fresh solution should be prepared.

Solutions made by diluting the 4000 FTU standard should also be stored in suitably labelled amber glass bottles and kept in a cool dark place. Solutions above 400 FTU have a shelf life of one month after which they should be discarded. Solutions below 400 FTU should be prepared from the 4000 FTU standard daily.

Solutions can be used outside of the storage life specified, but any results taken must acknowledge this and be accepted as less accurate. When using solutions, watch for flocculation (the particles in the solution will appear to link together), if this occurs discard the solution and prepare a fresh standard.

13.2 Fuller's Earth

The Fuller's Earth is supplied in a sealed 20g package, the package contains sufficient to make a 20,000 mg/l (20 g/l) solution when combined with 1 litre of water. Alternate solutions can be obtained by increasing the amount of water used as shown in the table below.

Solution Required (g/l)	Add pack to water (litres)
2.5	8.0
5.0	4.0
10.0	2.0
20.0	1.0
40.0	0.5

The following points should be observed when preparing and using Fullers Earth solutions:

- The water used should be freshly distilled or de-mineralised.
- Ensure the container used for the solution is clean.
- During preparation and use, keep the solution covered to prevent contamination.
- When using the solution it must be continually stirred to ensure accurate and consistent measurements and to prevent settling.

14 Technical Support

Technical Support is available by phone, fax, or email, the details of which are shown below.

- Phone: +44 (0) 1726 879800
- Fax: +44 (0) 1726 879801
- Email: techsupport@partech.co.uk
- Website: www.partech.co.uk

To enable us to provide quick and accurate technical support please have the following information ready when you contact us:

- Serial Number or original purchase details.
- Sensor Type, and Serial Number.
- Application details.
- Description of fault.
- Digital photos can also be useful to determine correct installation and suitability to the application.

14.1 Returning Equipment for Repair

If equipment needs to be returned to Partech for repair or service the following address should be used:

SERVICE DEPARTMENT
PARTECH INSTRUMENTS
ROCKHILL BUSINESS PARK
HUGHER BUGLE
ST AUSTELL
CORNWALL
PL26 8RA
UNITED KINGDOM

Please include the following information with the returned equipment. Also ensure that sensor is clean and adequately protected for transportation (Advice on packing can be provided by our service department).

- Contact name and phone number of person authorising the repair
- Site details including application sample point
- Return address for equipment
- Description of fault or service required
- Any special safety precautions because of nature of application

15 Technical Specification – TurbiTechw² LA, LS, HR Sensors

15.1 Physical

Dimensions..... 470 x 80mm (HxDiameter)
 Weight..... 2.2Kg (inc 10 metres of cable)
 Protection Class..... IP68
 Enclosure Material..... Black Acetal Co-Polymer
 Operating Temperature..... 0 to +50° C
 Wetted Parts..... Black Acetal, 316 Stainless Steel, Glass, Polyurethane, Nitrile
 Cable Entries..... Integral Cable Gland
 Cable Type..... 4 core, 2 Twisted Pair, 5mm O/D Polyurethane Coated
 Cable Length..... 10 metres Standard, 100 metres Max
 Pressure Rating (Depth)..... 10m WC, 2 bar
 Cleaning..... Self Cleaning (User defined by 7300w² Monitor)
 Clean Cycle..... 3500 Cycles

15.2 Electrical

Supply..... 12VDC from 7300w² Monitor
 Sensor Communication..... Partech ModTechw² Protocol

15.3 Measurement

TurbiTechw ² Sensor Type	Range	Accuracy	Limit of Detection	Minimum Operating Range
TurbiTechw ² LS	0 – 100 mg/l	±5% of measured value or ±0.5 FTU whichever is greater	0.5 FTU	0 – 10 FTU
TurbiTechw ² LS	0 – 500 mg/l	±5% of measured value or ±2.5 FTU whichever is greater	2.5 FTU	0 – 50 FTU
TurbiTechw ² LS (Extended)	0 – 1,000 mg/l	±5% of measured value or ±5 FTU whichever is greater	5 FTU	0 – 100 FTU
TurbiTechw ² LA	0 – 20,000 mg/l	±5% of measured value or ±100 FTU whichever is greater	100 mg/l	0 – 2,000 mg/l
TurbiTechw ² HR	0 – 50,000 mg/l	±5% of measured value or ±250 FTU whichever is greater	250 mg/l	0 – 5,000 mg/l

The actual measuring range will depend on the nature of the sample being monitored and cannot be guaranteed

Measurement Principle..... TurbiTechw² LS – 90° Light Scatter
 TurbiTechw² LA – Light Attenuation
 TurbiTechw² HR – Light Attenuation

Wavelength/Frequency..... 860nm Infrared
 Flow Rate..... Not affected by flow rate, avoid dead spots and extreme turbulence

15.4 Mounting Options

Mounting..... Dip
 Mounting Shaft..... 1 to 3 metres in 1 metre increments
 Handrail Attachments..... Contact Partech for full range of mounting options

